















## SPIS TREŚCI

	ŚCIANKA 1 DESKA PIONOWA 90X22mm, odstępy 45mm. ....	1 str
	ŚCIANKA 2 DESKA PIONOWA 90X22MM, 2/3 pełna .....	2 str
	ŚCIANKA 3 DESKA boazeryjna 15mm .....	3 str
	ŚCIANKA 4 DESKA 60x22mm, pozioma, odstępy 50mm .....	4 str
	ŚCIANKA 5 Żaluzja A1 z prześwitem DESKA 85x22mm, .....	5 str
	ścięta pod kątem 45st. w odstępie 50mm	
	ŚCIANKA 6 Żaluzja A2 z prześwitem DESKA 85x22mm, .....	6 str
	ścięta pod kątem 45st. w odstępie 50mm	
	ŚCIANKA 7 Żaluzja B1 bez prześwitu DESKA 85x22mm, .....	7 str
	ścięta pod kątem 45st. w odstępie 30mm	
	ŚCIANKA 8 Żaluzja B2 bez prześwitu DESKA 85x22mm, .....	8 str
	ścięta pod kątem 45st. w odstępie 30mm	
	ŚCIANKA 9 Żaluzja C bez prześwitu, drobna DESKA 55x22mm, .....	9 str
	ścięta pod kątem 45st. w odstępie 10mm	
	ŚCIANKA 10 Żaluzja D bez prześwitu, rombiasta DESKA 77x22mm, ..	10 str
	ścięta pod kątem 45st. w odstępie 10mm	
	ŚCIANKA 11 Żaluzja E bez prześwitu, schodkowa DESKA 70x22mm, ..	11 str
	ścięta pod kątem 90st. odstęp 50mm	
<input type="checkbox"/>	ŚCIANKA 12 Cienka listwa, DESKA 22x25 mm, .....	12 str
<input type="checkbox"/>	ŚCIANKA 13 Lamle pionowe, KANTÓWKA 45X70 mm, .....	13 str
<input type="checkbox"/>	NAKŁADKA Listwa 22x24 mm, .....	14 str

	<b>SŁUPY OZDOBNE</b> Belka 10x10cm, zacinana pod kątem, ..... frezowana. ....	15 str
	<b>PANEL1</b> Pełen ażur. ....	16 str
	<b>PANEL2</b> ażur fala lub prosty, 2/3 deska boazeryjna. ....	17 str
	<b>PANEL3</b> ażur, 2/3 listwy poziome. ....	18 str
	<b>Boazeria 1</b> grubość 15mm, standard.	
	<b>Boazeria 2</b> grubość 20mm	
	<b>Boazeria 3</b> grubość 20mm, z frezowaniem	
	<b>Boazeria 4</b> grubość 20mm, półbal. ....	19 str

# ŚCIANKA 1

DESKA PIONOWA 90X22mm, odstępy 45mm.

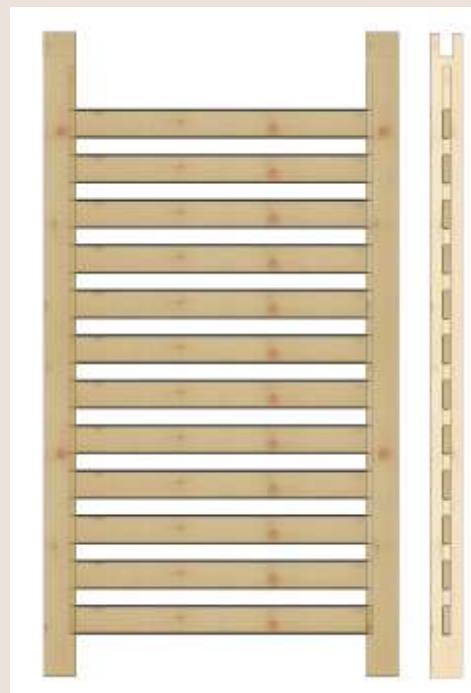
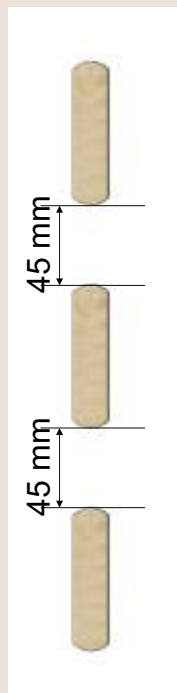
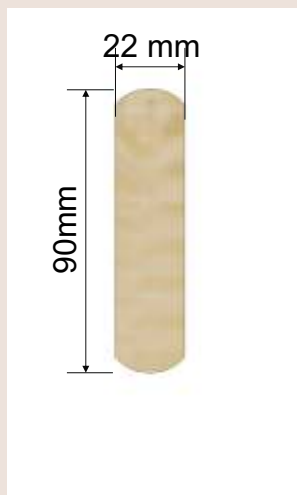

# ŚCIANKA 2

DESKA PIONOWA 90X22MM, 2/3 pełna

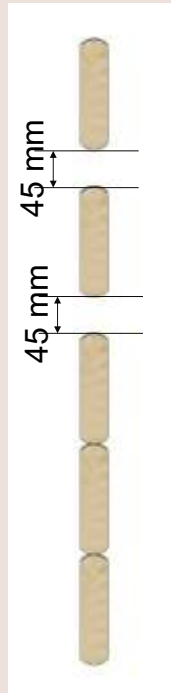
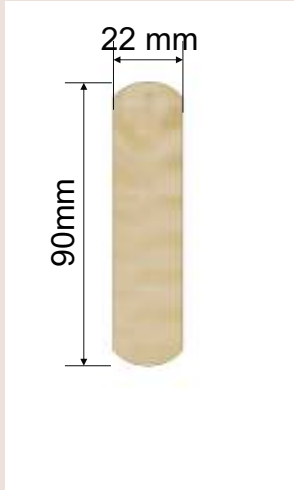

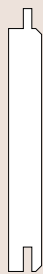

# ŚCIANKA 3

DESKA boazeryjna 15mm

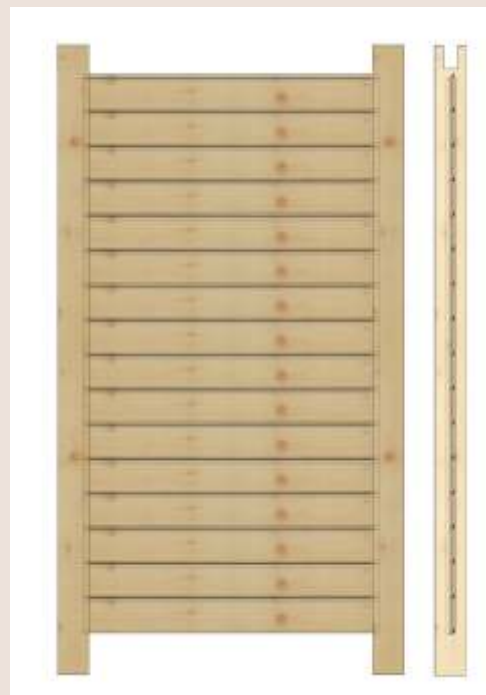
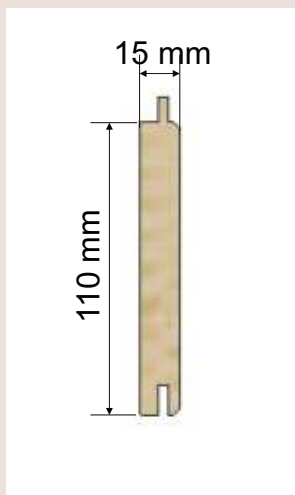

# ŚCIANKA 4

DESKA 60x22mm, pozioma, odstępy 50mm

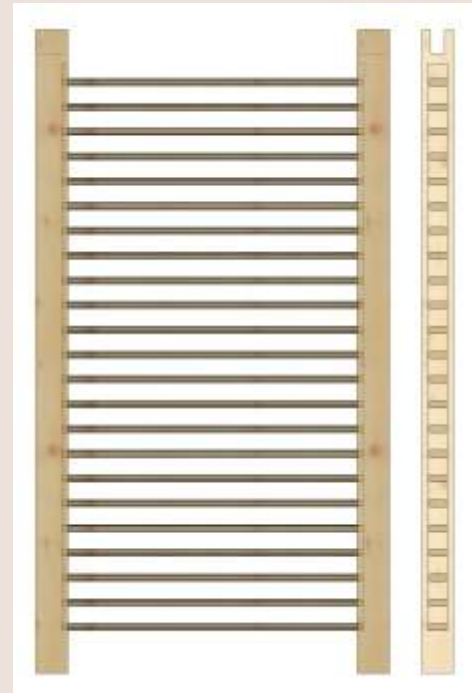
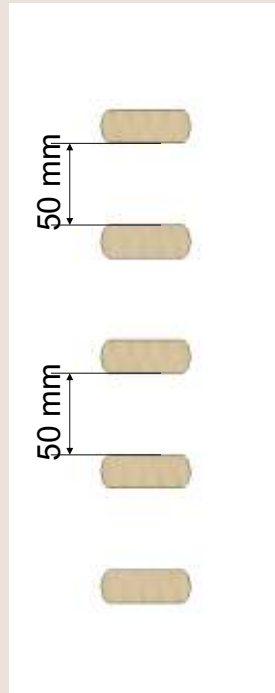
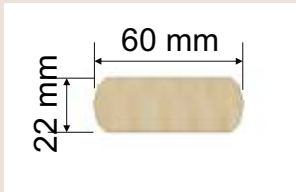

# ŚCIANKA 5

Żaluzja A1 z prześwitem

DESKA 85x22mm, ścięta pod kątem 45st. w odstępie 50mm

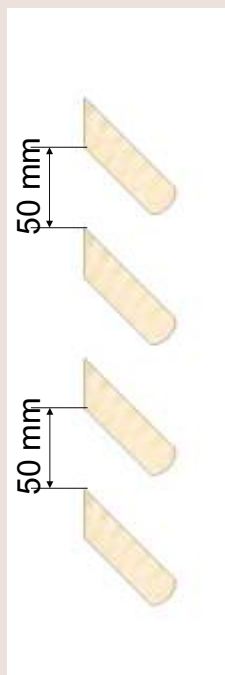
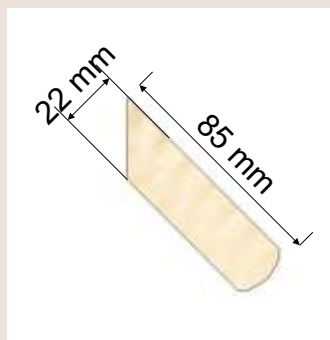
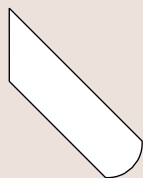

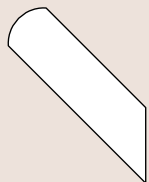

# ŚCIANKA 6

## Żaluzja A2 z prześwitem

DESKA 85x22mm, ścięta pod kątem 45st. w odstępnie 50mm

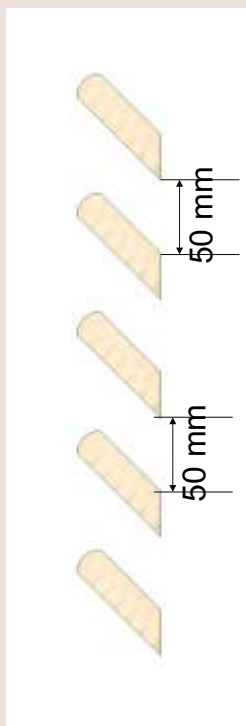
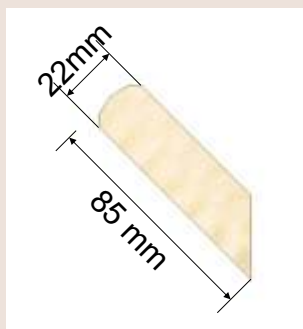

# ŚCIANKA 7

Żaluzja B1 bez prześwitu

DESKA 85x22mm, ścięta pod kątem 45st. w odstępie 30mm

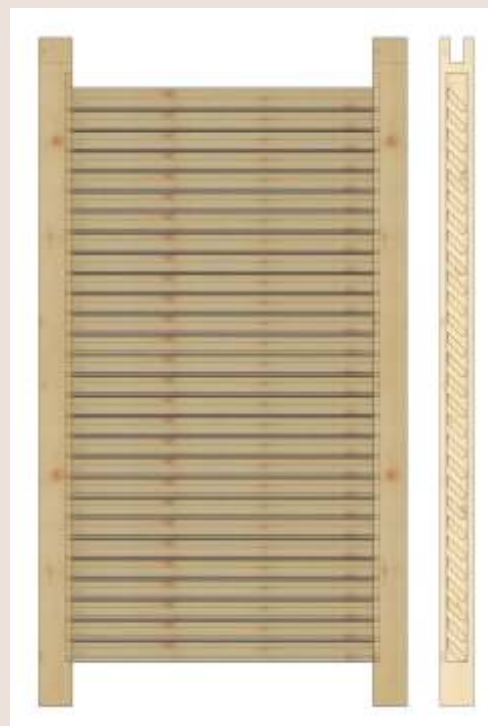
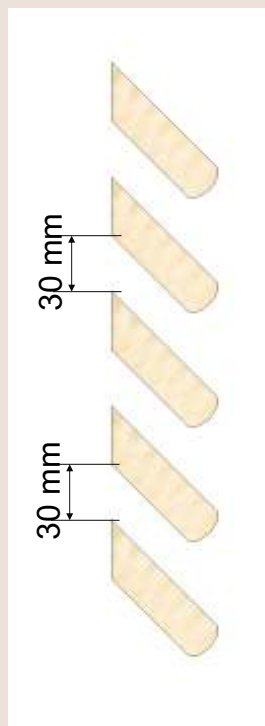
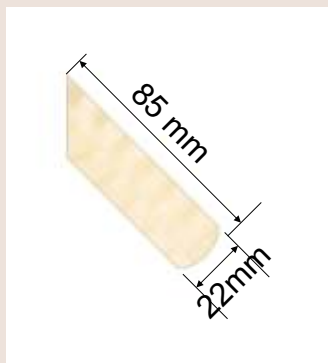
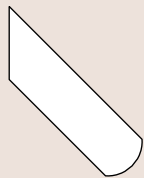

# ŚCIANKA 8

## Żaluzja B2 bez prześwitu

DESKA 85x22mm, ścięta pod kątem 45st. w odstępnie 30mm

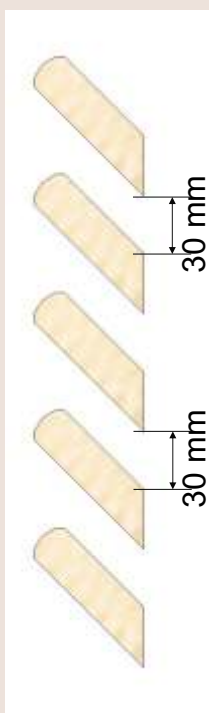
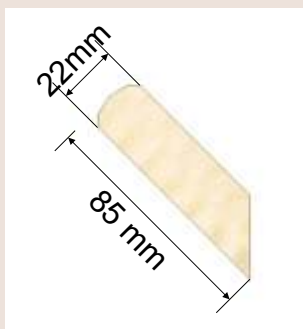
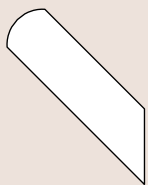

# ŚCIANKA 9

Żaluzja C bez prześwitu, drobna

DESKA 55x22mm, ścięta pod kątem 45st. w odstępie 10mm

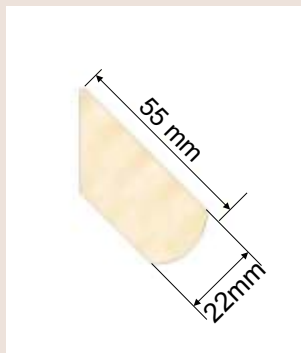
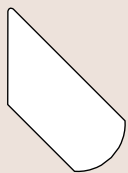

# ŚCIANKA 10

Żaluzja D bez prześwitu, rombiasta

DESKA 77x22mm, ścięta pod kątem 45st. w odstępie 10mm

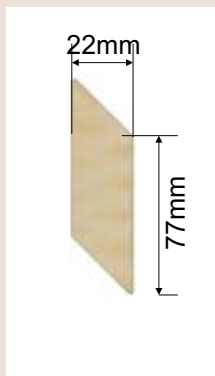

# ŚCIANKA 11

Żaluzja E bez prześwitu, schodkowa

DESKA 70x22mm, ścięta pod kątem 90st. odstęp 50mm

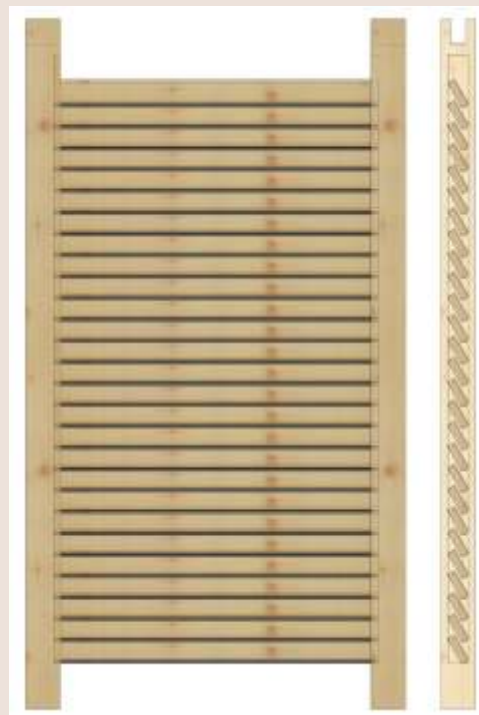
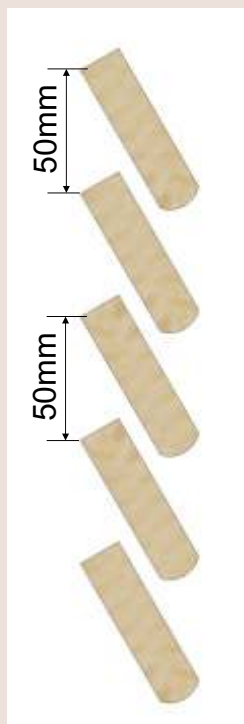
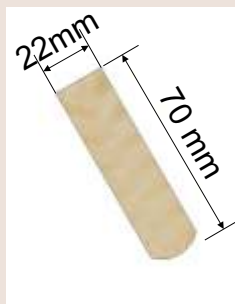
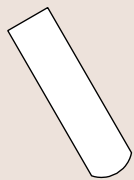

# ŚCIANKA 12

Cienka listwa, LISTWA 22x24mm,

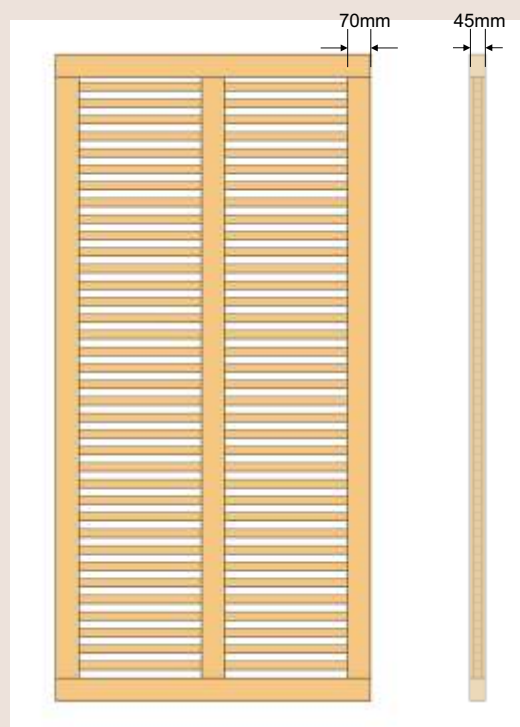
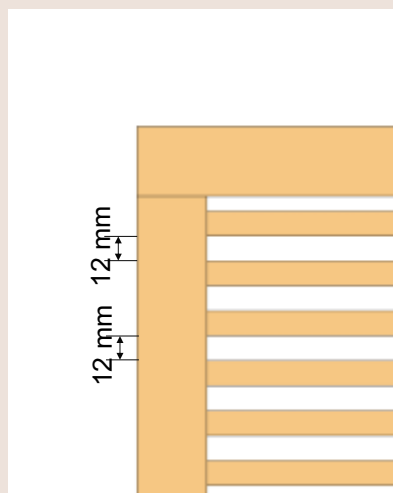
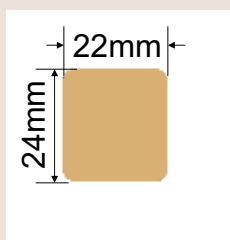

# NAKŁADKA

LISTWA 22x24mm,

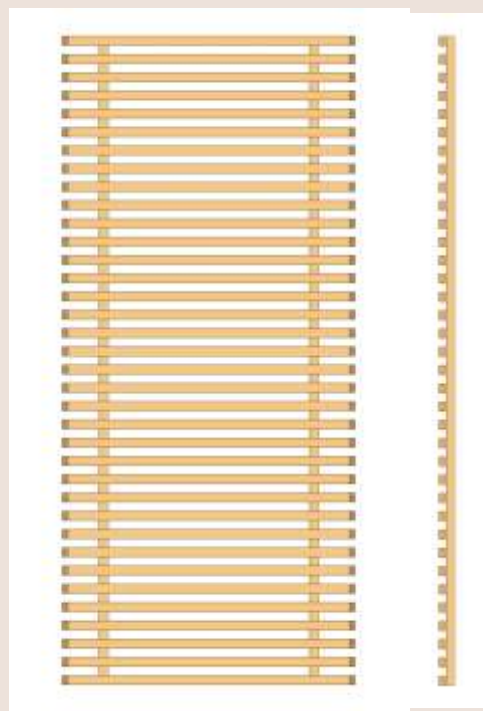
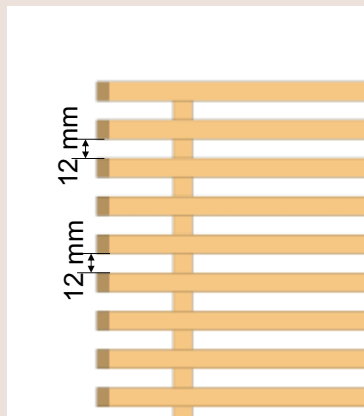
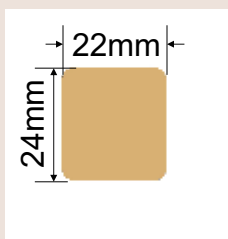

# ŚCIANKA 13

Lamele pionowe, KANTÓWKA 45x70mm

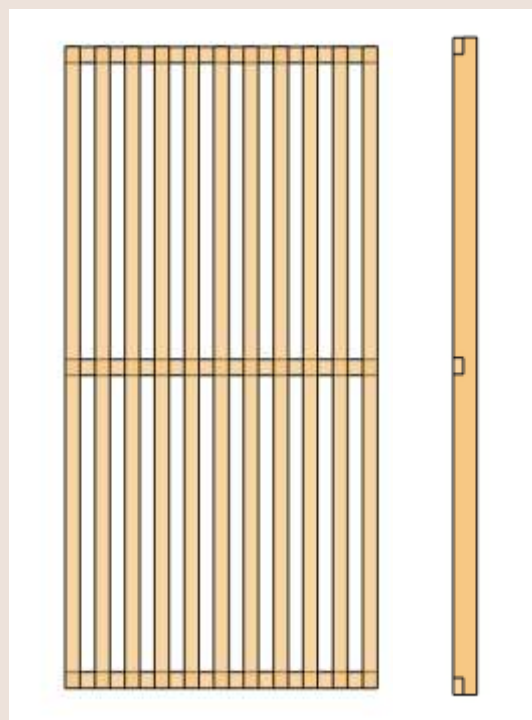
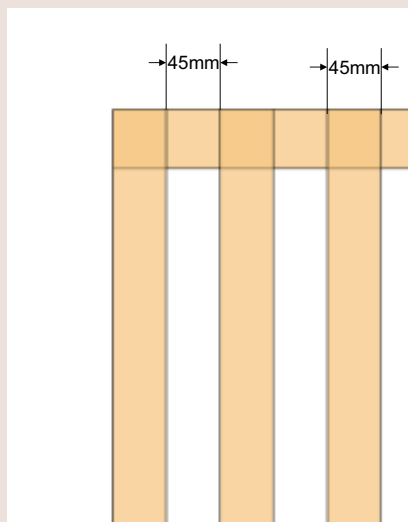
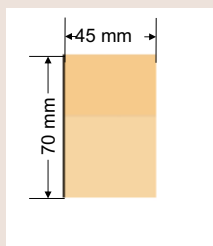

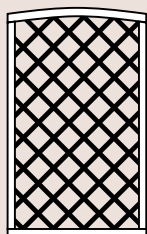

# PANEL1

Peŝen aŝur.





# SŁUPY OZDOBNE

Belka 10x10cm, zacinana pod kątem, frezowana.

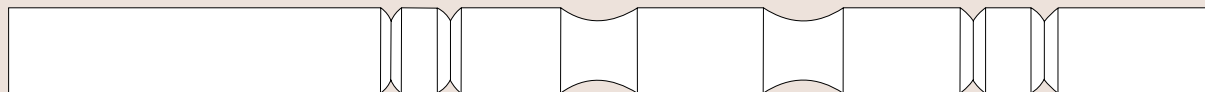

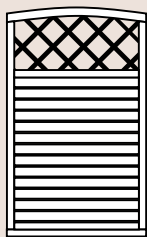

# PANEL2

ażur fala lub prosty, 2/3 deska boazeryjna.

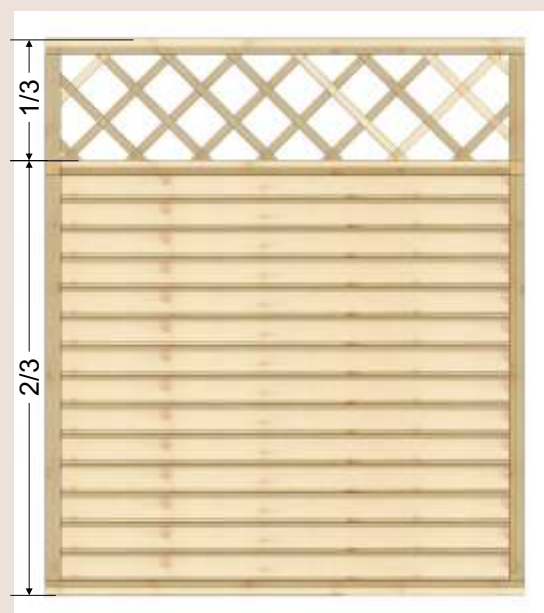
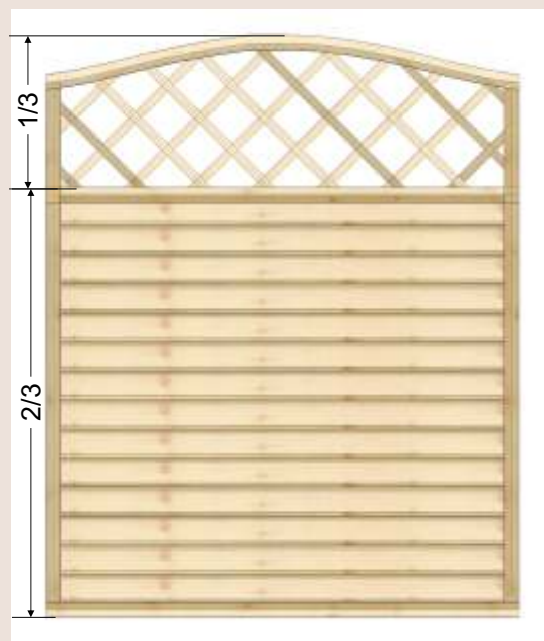

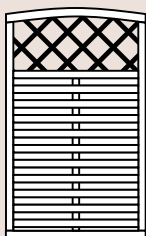

# PANEL 3

ażur, 2/3 listwy poziome.

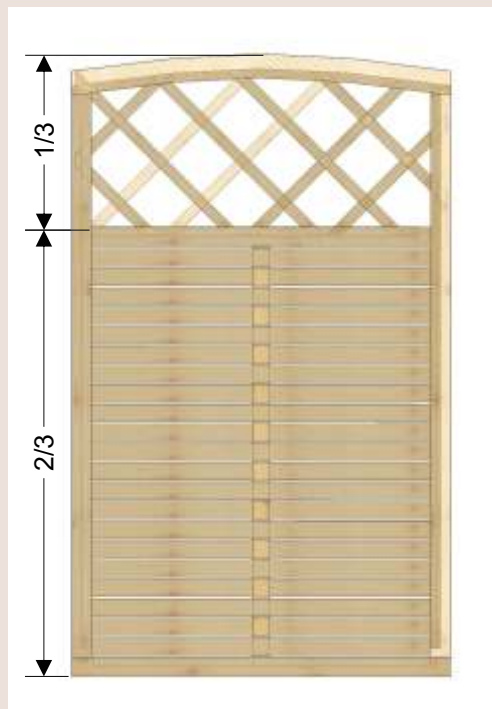

## Boazeria 1

grubość 15mm, standard.



## Boazeria 2

grubość 20mm



## Boazeria 3

grubość 20mm, z frezowaniem



## Boazeria 4

grubość 20mm, półbal

